

Stack Parking – Stackers With Pit

Stackers with pit add independent access to each car. Both upper and lower level cars are parked on platforms that move up and down together allowing each car to be driven on or off independently of each other.

► **swiss-park S-22**

Dimensions

All space requirements are minimum finished dimensions. Tolerances for space requirements + 1". Illustration's dimensions in cm.

EB (single platform) = 2 vehicles
DB (double platform) = 4 vehicles

Type	H	DH**
S-22 170	10'-8"	5'-2"
S-22 185*	11'-2"	5'-8"
S-22 195	11'-6"	6'-0"

* standard type
** without car

Suitable for

Standard passenger car and station wagon. Height and length according to contour.

Type	H	car height	
		upper floor	ground floor
S-22 170	10'-8"	4'-11"	4'-11"
S-22 185*	11'-2"	4'-11"	5'-5"
S-22 195	11'-6"	4'-11"	5'-9"

* standard type

width	6'-3"
weight	max. 4400 lbs
wheel load	max. 1100 lbs

Garage with door in front of the stack parking system

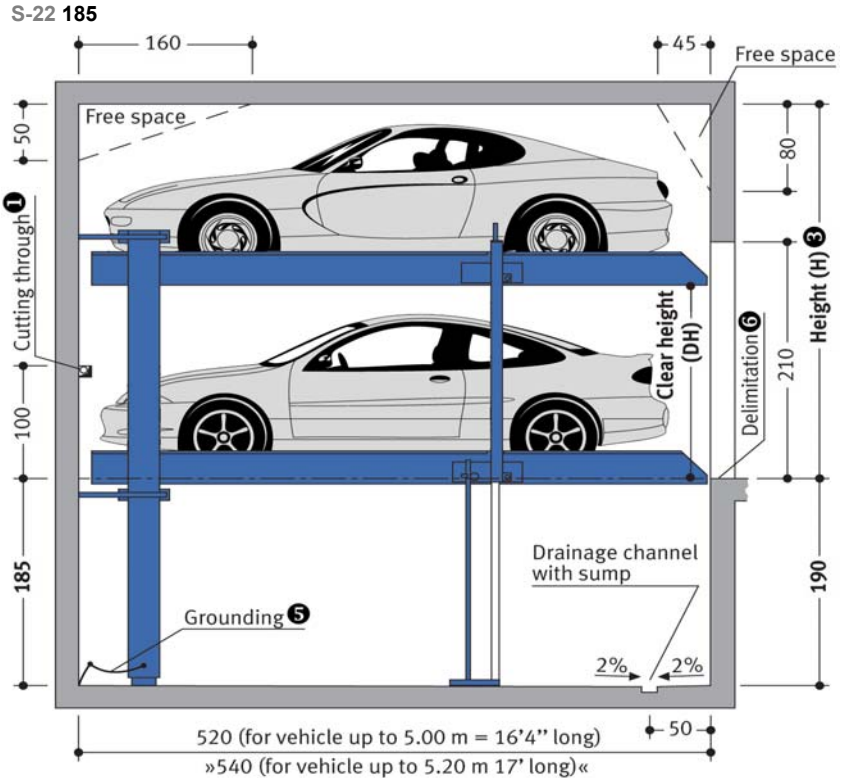
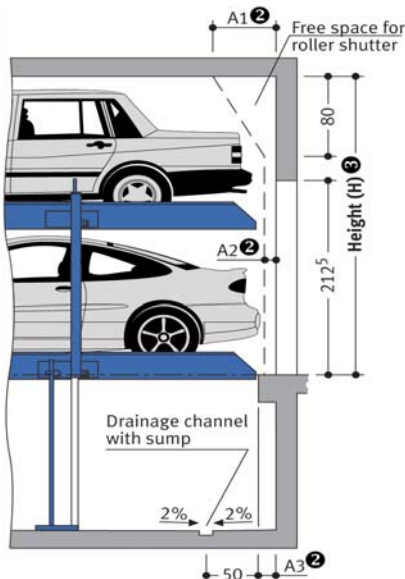

S-22 170

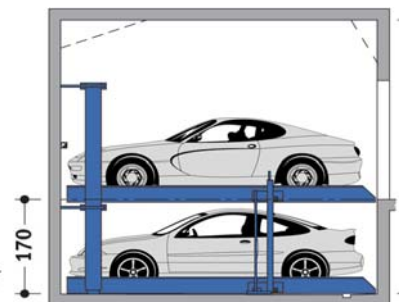

S-22 195 ④

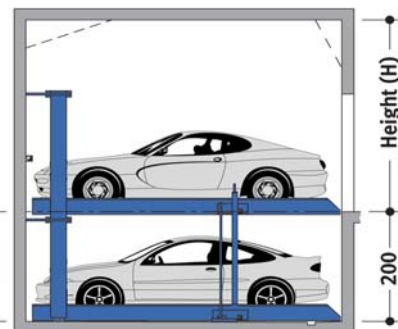

Notes

- ① For dividing walls: cutting through 4 x 4 in (for pipes).
- ② Dimensions A1, A2 and A3 must be coordinated with the door supplier.
- ③ If the total height is greater, the max. vehicle height for the upper parking space increases accordingly.
- ④ For the greatest possible ease-of-use, we recommend platform widths of 8'-3" to 8'-11" (EB) or 16'-5" (DB).
- ⑤ Potential equalization from foundation grounding connection to system.
- ⑥ In compliance with DIN EN 14 010, 4 in wide yellow-black markings compliant to ISO 3864 must be applied by the customer to the edge of the pit in the entry area to mark the danger zone (see »load plan« page 3).

Attention

For cars up to a length of 17'-1" please note: Pit length 17'-9" max. authorized loading 5500 lbs (wheel load max. 1375 lbs), usable platform width 8'-3" to 8'-11. Only available on single wide platforms (EB).

Horizontal Design Dimensions

Dividing walls

Single Platform (EB)



usable platform width	B1
7'-7" *	8'-7"
7'-11"	8'-11"
8'-3"	9'-3"
8'-7"	9'-7"
8'-11"	9'-11"

Double Platform (DB)

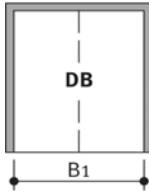

usable platform width	B1
15'-1" *	16'-1"
15'-5"	16'-5"
15'-9"	16'-9"
16'-1"	17'-1"
16'-5"	17'-5"

Single and Double Platform (EB + DB) – Example

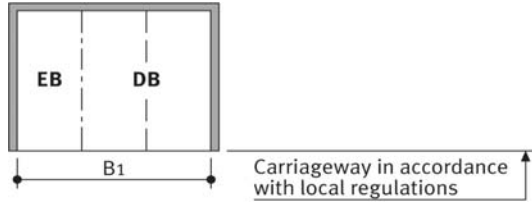

usable platform width	B1
7'-7"+15'-1"	24'-8"
7'-11"+15'-5"	25'-4"
8'-3"+15'-9"	26'-0"
8'-3"+16'-5"	26'-8"
8'-11"+16'-5"	27'-4"

* standard type

Columns inside of pit

Single Platform (EB)

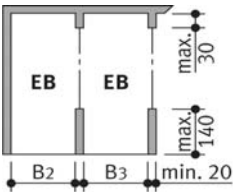

usable platform width	B2	B3
7'-7" *	8'-5"	8'-3"
7'-11"	8'-9"	8'-7"
8'-3"	9'-1"	8'-11"
8'-7"	9'-5"	9'-3"
8'-11"	9'-9"	9'-7"

Double Platform (DB)

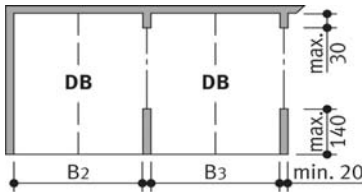

usable platform width	B2	B3
15'-1" *	15'-11"	15'-7"
15'-5"	16'-3"	15'-11"
15'-9"	16'-7"	16'-3"
16'-1"	16'-11"	16'-7"
16'-5"	17'-3"	16'-11"

Single and Double Platform (EB + DB) – Example

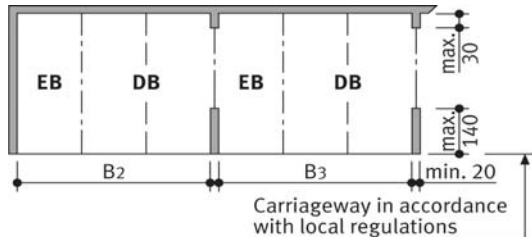

usable platform width	B2	B3
7'-7"+15'-1"	24'-5"	24'-1"
7'-11"+15'-5"	25'-1"	24'-9"
8'-3"+15'-9"	25'-9"	25'-5"
8'-3"+16'-5"	26'-5"	26'-1"
8'-11"+16'-5"	27'-1"	26'-9"

* standard type

Approach

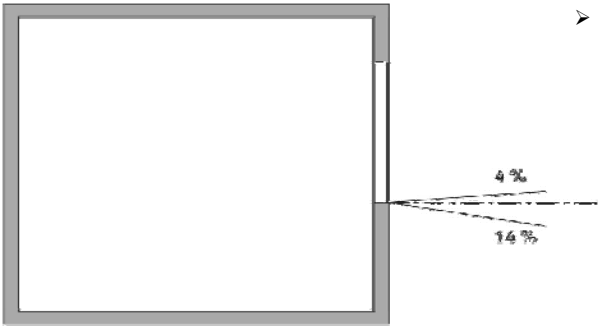

➤ The illustrated maximum approach angles must not be exceeded. Incorrect approach angles will cause serious manoeuvring & positioning problems on the parking system for which the local agency of **SWISS-PARK** accepts no responsibility.

Load plan

Forces in kN

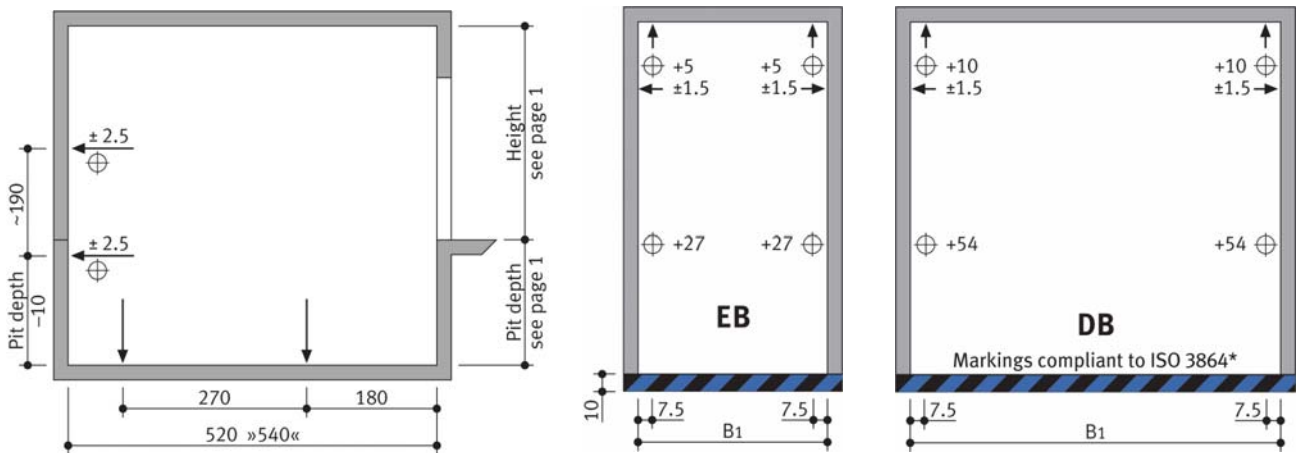

Units are anchored to the slab below. Drilling depth: approx. 6".

Floor and walls below the drive-in level are to be made of concrete (quality minimum C20/25)!

* = Colors used in this illustration are not ISO 3864 compliant

Installation data

Free space for longitudinal and vertical ducts (e.g. ventilation)

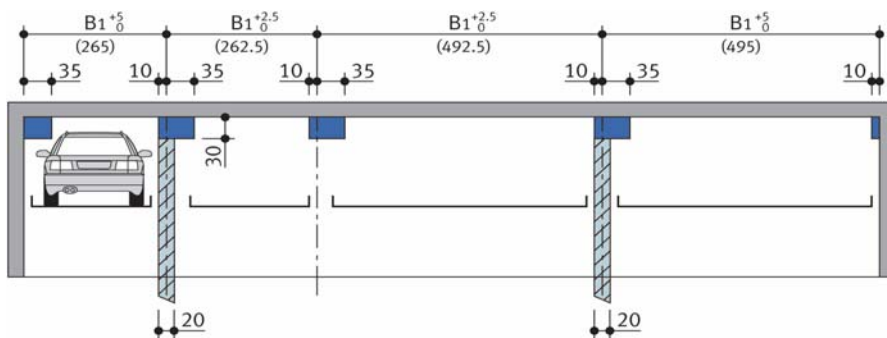

B1, B2, B3 = (see table on page 2)

Free space for vertical pipelines, ventilation branch canals

Free space for horizontal ducting

Approach level

Free space only applicable if vehicle is parked forward = FRONT FIRST and driver's door on the left side.

() = Dimensions in brackets illustrate an example for usable platform width 7'-7"/15'-1".

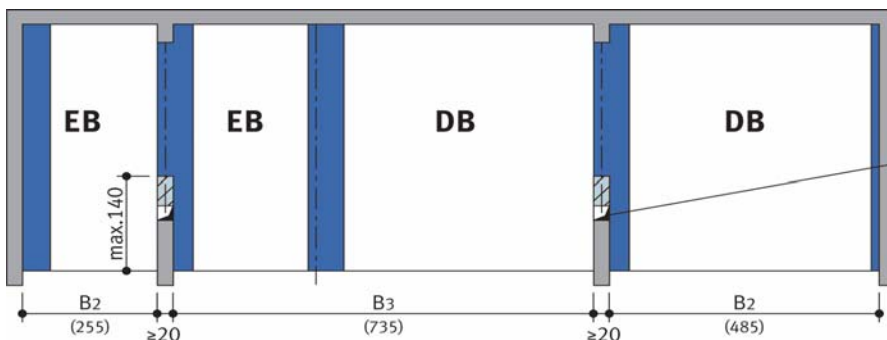

Example for ventilation branch canal and/or vertical pipelines.

Electrical installation

Installation diagram

Electrical data (to be performed by the customer)

No.	Quantity	Description	Position	Frequency
1	1	Electricity meter	in the supply line	
2	1	Main fuse: 3 x fuse 16 A (slow) or circuit breaker 3 x 16 A (trigger characteristic K, G or C)	in the supply line	1 per unit
3	1	Supply line 5 x 2.5 mm ² (3 PH + N + PE) with marked wire and protective conductor	to main switch	1 per unit
4	1	Lockable main switch	defined at the plan evaluation	1 per unit
5	1	Supply line 5 x 2.5 mm ² (3 PH + N + PE) with marked wire and protective conductor	from main switch to unit	1 per unit
6	every 30 feet	Foundation earth connector	corner pit floor	
7	1	Equipotential bonding in accordance with DIN EN 60204 from foundation earth connector to the system		1 per system

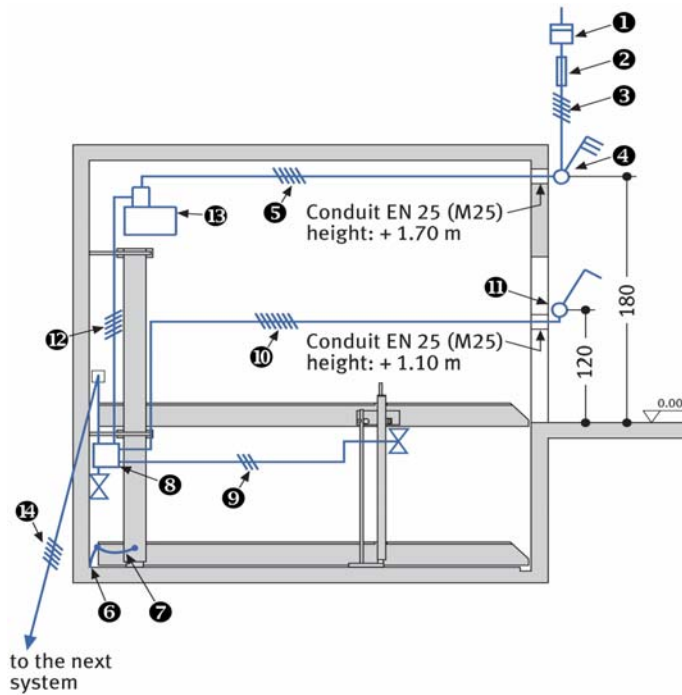

Electrical data (included in delivery of SWISS-PARK Systems)

No.	Description
8	Terminal box
9	Control line 3 x 0.75 mm ² (PH + N + PE)
10	Control line 7 x 1.5 mm ² with marked wire and protective conductor
11	Operating device
12	Control line 5 x 1.5 mm ² with marked wire and protective conductor
13	Hydraulic unit 3.0 kW, three-phase current, 400 V / 50 Hz
14	Control line 5 x 1.5 mm ² with marked wire and protective conductor

Technical data

Range of application

Generally, this parking system is not suited for short-time parkers (temporary parkers). Please do not hesitate to contact your local **SWISS-PARK** agency for further assistance.

Units

Low-noise power units mounted to rubber-bonded-to metal mountings are installed. Nevertheless we recommend that parking system's garage be built separately from the dwelling.

Available documents

- wall recess plans
- maintenance offer/contract
- declaration of conformity
- test sheet on airborne and slid-borne sound

Corrosion protection

See separate sheet regarding corrosion protection.

Railings

If the permissible drop opening is exceeded, railings are to be mounted on the systems. If there are traffic routes next to or behind the installations, railings compliant to DIN EN 294 must be installed by the customer. Railings must also be in place during construction.

Environmental conditions

Environmental conditions for the area of **SWISS-PARK** Systems: Temperature range -10 to $+40^{\circ}$ C. Relative humidity 50 % at a maximum outside temperature of $+40^{\circ}$ C. If lifting or lowering times are specified, they refer to an environmental temperature of $+10^{\circ}$ C and with the system set up directly next to the hydraulic unit. At lower temperatures or with longer hydraulic lines, these times increase.

Sound insulation

According to DIN 4109 (Sound insulation in buildings), para. 4, annotation 4, **SWISS-PARK** Systems are part of the building services (garage systems).

Normal sound insulation: DIN 4109, para. 4, Sound insulation against noises from building services.

Table 4 in para. 4.1 contains the permissible sound level values emitted from building services for personal living and working areas. According to line 2 the maximum sound level in personal living and working areas must not exceed 30 dB (A). Noises created by users are not subject to the requirements (see table 4, DIN 4109). The following measures are to be taken to comply with this value:

- Sound protection package according to offer/order
- Minimum sound insulation of building $R'w = 57$ dB (to be provided by customer)

Increased sound insulation (special agreement): DIN 4109, Amendment 4, Information on planning and execution, proposals for increased sound insulation.

Agreement: Maximum sound level in personal living and working areas 25 dB (A). Noises created by users are not subject to the requirements (see table 4, DIN 4109).

The following measures are to be taken to comply with this value:

- Sound protection package according to offer/order
- Minimum sound insulation of building $R'w = 62$ dB (to be provided by customer)

Note: User noises are noises created by individual users in our **SWISS-PARK** Systems. These can be noises from accessing the platforms, slamming of vehicle doors, motor and brake noises.

To be performed by the customer

Safety fences

Any constraints that may be necessary according to DIN EN 294 in order to provide protection for the park pits for pathways directly in front, next to or behind the unit. This is also valid during construction. Railings for the system are included in the series and delivered when necessary.

Numbering of parking spaces

Consecutive numbering of parking spaces.

Building services

Lighting, ventilation, fire extinguishing and fire alarm systems.

Drainage

For the front area of the pit we recommend a drainage channel to be connected to a floor drain system or sump (20 x 20 x 8 in). The drainage channel may be sloped laterally but not the pit floor itself (longitudinal incline is possible). For reasons of environmental protection we recommend to paint the pit floor, and to provide oil and petrol separators in the connections to the public sewage network.

Marking

According to DIN EN 14 010, a warning that identifies this danger area must be placed in the entrance area that conforms to ISO 3864. This must be done according to EN 92/58/EWG for systems with a pit (platforms within the pit) 4 in from the edge of the pit.

Wall cut-through

Any necessary wall cut-through according to page 1.

Electrical supply to the main switch

Suitable electrical supply to the main switch and the control wire line must be provided by the customer during installation. The functionality can be monitored on site by our fitters together with the electrician. If this cannot be done during installation for some reason for which the customer is responsible, the customer must commission an electrician at their own expense and risk.

Operating device

Cable conduits and recesses for operating device (for double wing doors: please contact the local agency of **SWISS-PARK**).

Operating device exposed

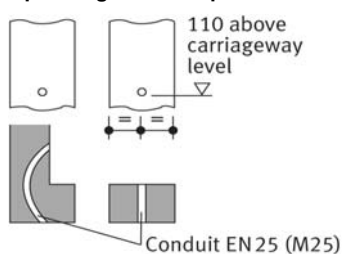

Operating device concealed

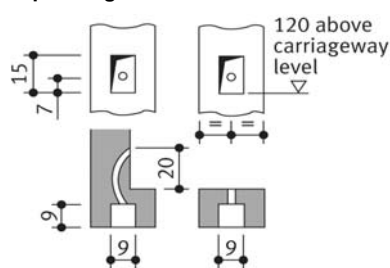

If the following are not included in the quotation, they will also have to be provided / paid for by the customer:

- Costs for final technical approval by an authorized body

Description Single platform (EB) and Double platform (DB)

General description

SWISS-PARK System providing independent parking spaces for 2 cars (EB), 2 x 2 cars (DB).

Dimensions are in accordance with the underlying dimensions of parking pit, height and width.

The parking bays are accessed horizontally (installation deviation $\pm 1\%$).

Due to the special lifting and bearing construction lifting of the doors is not restricted.

Vehicles are positioned on each parking space using wheel stops on the right side (adjust according to operating instructions).

Operation via operating device with hold-to-run-device using master keys.

The operating elements are usually mounted either in front of the column or on the outside of the door frame

Operating instructions are attached to each operator's stand.

For garages with doors at the front of the parking system the special dimensional requirements have to be taken into account.

SWISS-PARK System consisting of

- 2 steel pillars (mounted on the floor)
- 2 sliding platforms (mounted to the steel pillars with sliding bearings)
- 2 platforms
- 1 mechanic synchronization control system (to ensure synchronous operation of the hydraulic cylinders while lowering and lifting the platform)
- 2 hydraulic cylinders
- 2 rigid supports (connect the platforms)
- 2 chains and pocket wheels
- 1 automatic hydraulic safety valve (prevents accidental lowering of the platform while accessing the platform)
- Dowels, screws, connecting elements, bolts, etc.
- The platforms and parking spaces are end-to-end accessible for parking.

Platforms consist of:

- | | |
|--------------------------|--|
| ■ Platform base sections | ■ Central side member [only DB] |
| ■ Adjustable wheel stops | ■ Cross members [DB long and short cross members] |
| ■ Canted access plates | ■ Safety railings – along the upper and lower platform (if required) |
| ■ Side members | ■ Screws, nuts, washers, distance tubes, etc. |

Hydraulic system consisting of

- | | |
|----------------------|-------------------------|
| ■ Hydraulic cylinder | ■ Screwed joints |
| ■ Solenoid valve | ■ High-pressure hoses |
| ■ Safety valve | ■ Installation material |
| ■ Hydraulic conduits | |

Electric system consisting of

- Operating device (Emergency Stop, lock, 1 master key per parking space)
- Terminal box at wall valve

Hydraulic unit consisting of

- Hydraulic power unit (low-noise, installed onto a console with a rubber-bonded-to-metal mounting)
- Hydraulic oil reservoir
- Oil filling
- Internal geared wheel pump
- Pump holder
- Clutch
- 3-phase-AC-motor (3.0 kW, 230/400 V, 50 Hz)
- Contactor (with thermal overcurrent relay and control fuse)
- Test manometer
- Pressure relief valve
- Hydraulic hoses (which reduce noise transmission onto the hydraulic pipe)

We reserve the right to change this specification without further notice

The **SWISS-PARK** company reserves the right in the course of technical progress to use newer or other technologies, systems, processes, procedures or standards in the fulfillment of their obligations other than those originally offered provided the customer derives no disadvantage from their so doing.